

Fort Carson Townsend Reservoir

Species of Fish

Largemouth Bass
(*Micropterus salmoides*)



Bluegill
(*Micropterus salmoides*)

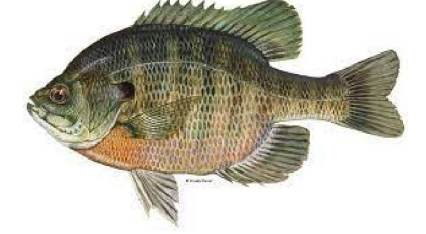

Catfish
(*Siluriformes*)



Rainbow Trout
(*Oncorhynchus mykiss*)



Townsend Reservoir Bag Limits

- Bass (5)
- Catfish (10)
- Rainbow Trout (4)
- Crappie / Bluegill (20)

iSportsman...
Hunting / Fishing: (719) 217-3148
Wildlife: (719) 646-9065

Wildlife Office B1219, Rm. 340, 319, & 320
(Hours: 0700-1530 Mon.-Fri.)

For Additional Information
Please Click The Link Below
<https://fortcarson.isportsman.net>

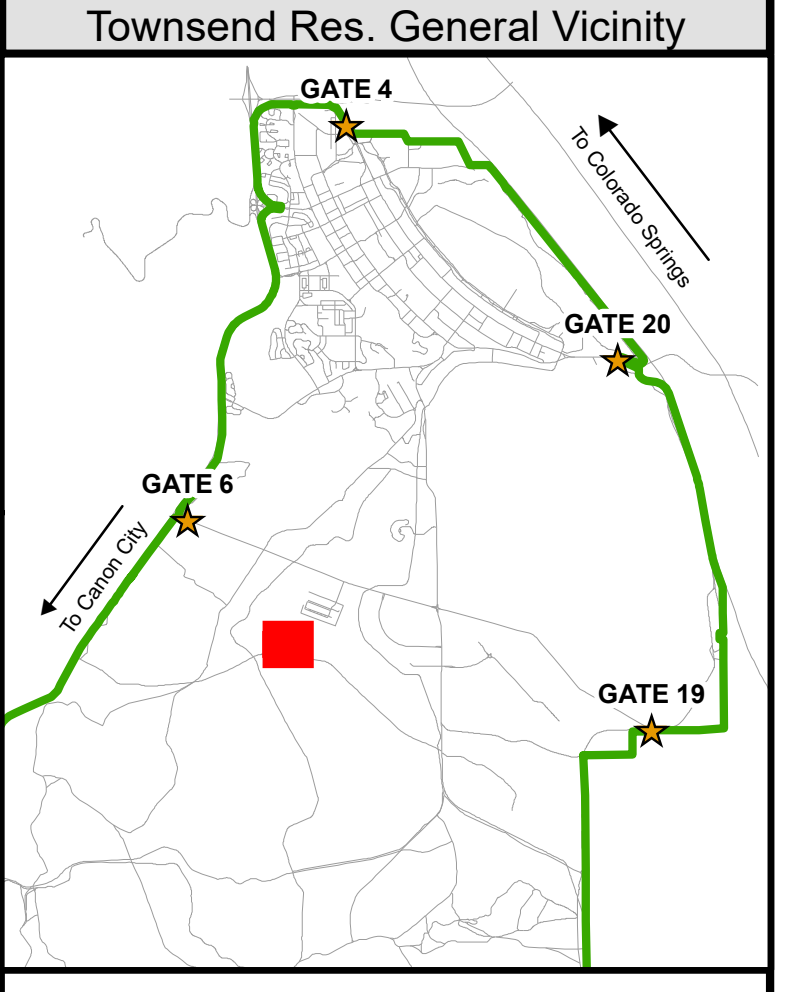
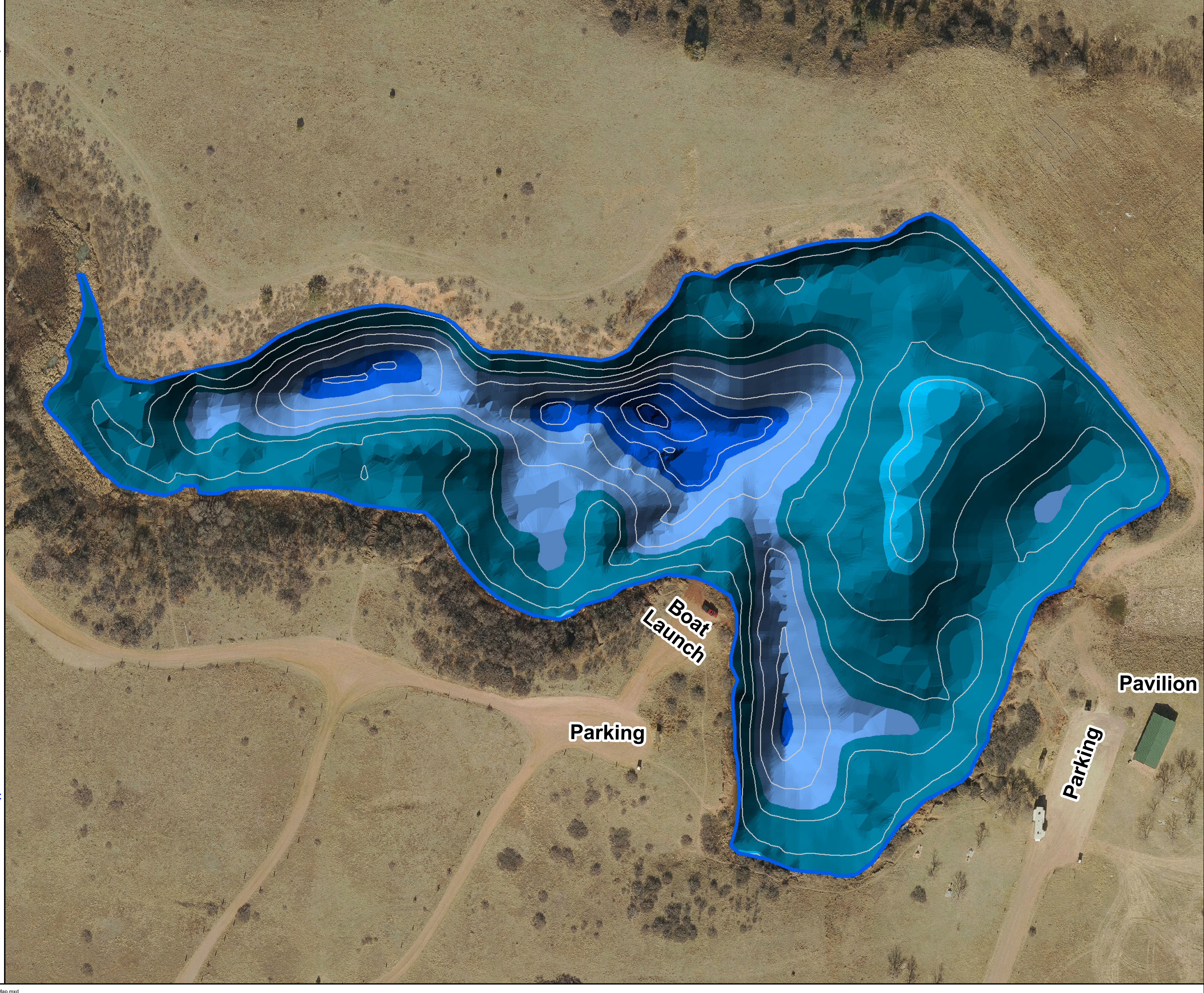

Legend

- Townsend Res. (10 Ac.)
- Townsend Contours (5ft)

Subsurface Depth

- 1 - 11 Feet
- 11 - 22 Feet
- 22 - 33 Feet
- 33 - 44 Feet
- 44 - 55 Feet

FOR OFFICIAL USE ONLY

IF YOU SEE ANY ERRORS OR OMISSIONS ON THIS MAP, PLEASE CALL DPW GIS OR MARK YOUR CHANGES AND RETURN FOR UPDATES.

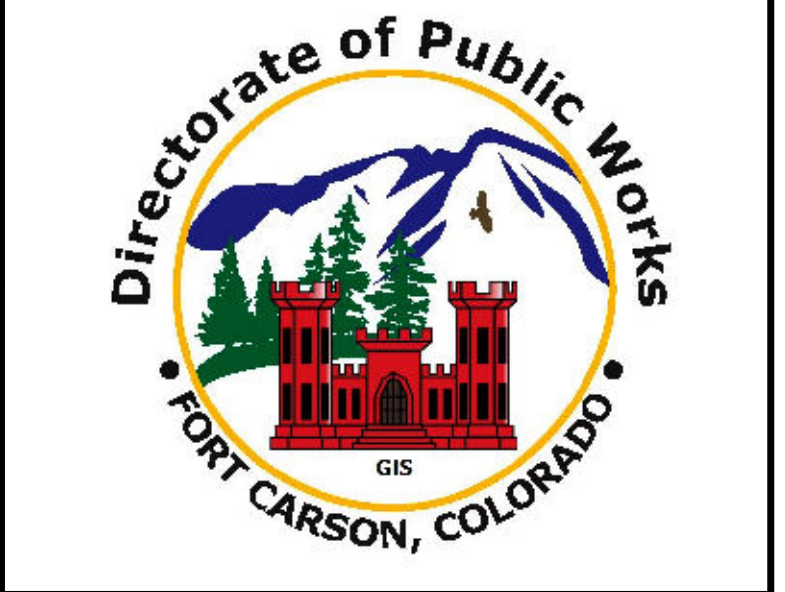
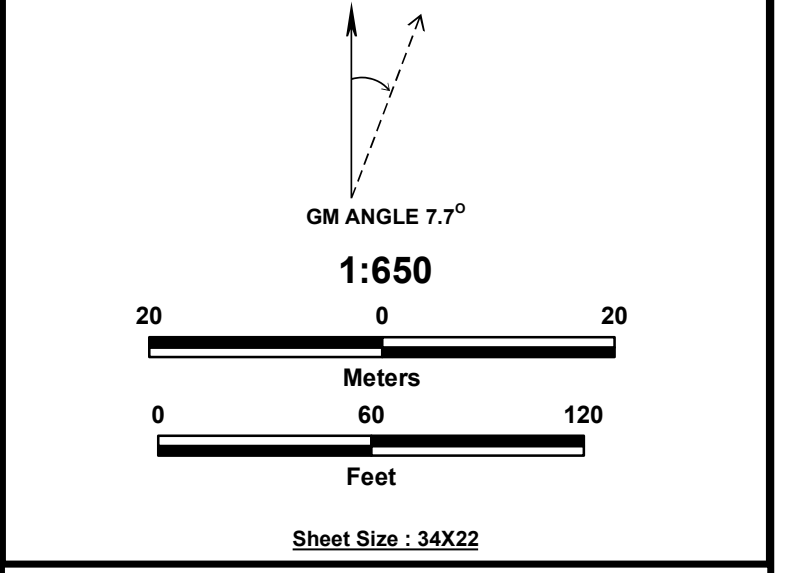

FORT CARSON		
COMMON INSTALLATION PICTURE		
Townsend Reservoir Fishing Map		
DPW ENGINEERING DIVISION GIS		
PRODUCTION: DPW GIS / TUKUH TECH. PHONE: (719) 524-1085		
PREPARED BY: JC	CHECKED BY: JC	PREPARED: 5/24/2021
FILE NAME: Townsend Fishing Map	SHEET: 1 of 1	